

G5.1

"CUTTY" VEGETABLE CUTTER



■
30+ servings
per day

■
Gastronomy

■
Hotels

■
Catering
services

■
Party services

■
Diet kitchens

- XXL filling chute for bulky vegetables
- Practical space for 1/1 GN-containers
- Basic unit and components made of stainless steel
- Infinitely variable speed control
- Basic carrier disc
- Removable dishwasher suitable functional components

FUNCTIONAL DETAILS



Basic unit made of stainless steel



1 Easy cleaning by removal of the cutting lid, dishwasher-safe



2 Filler necks for elongated material (dia. 61 mm)



3 XXL filling chute as depot for processing large volumes in one step (Cross-sectional area 173 cm²)

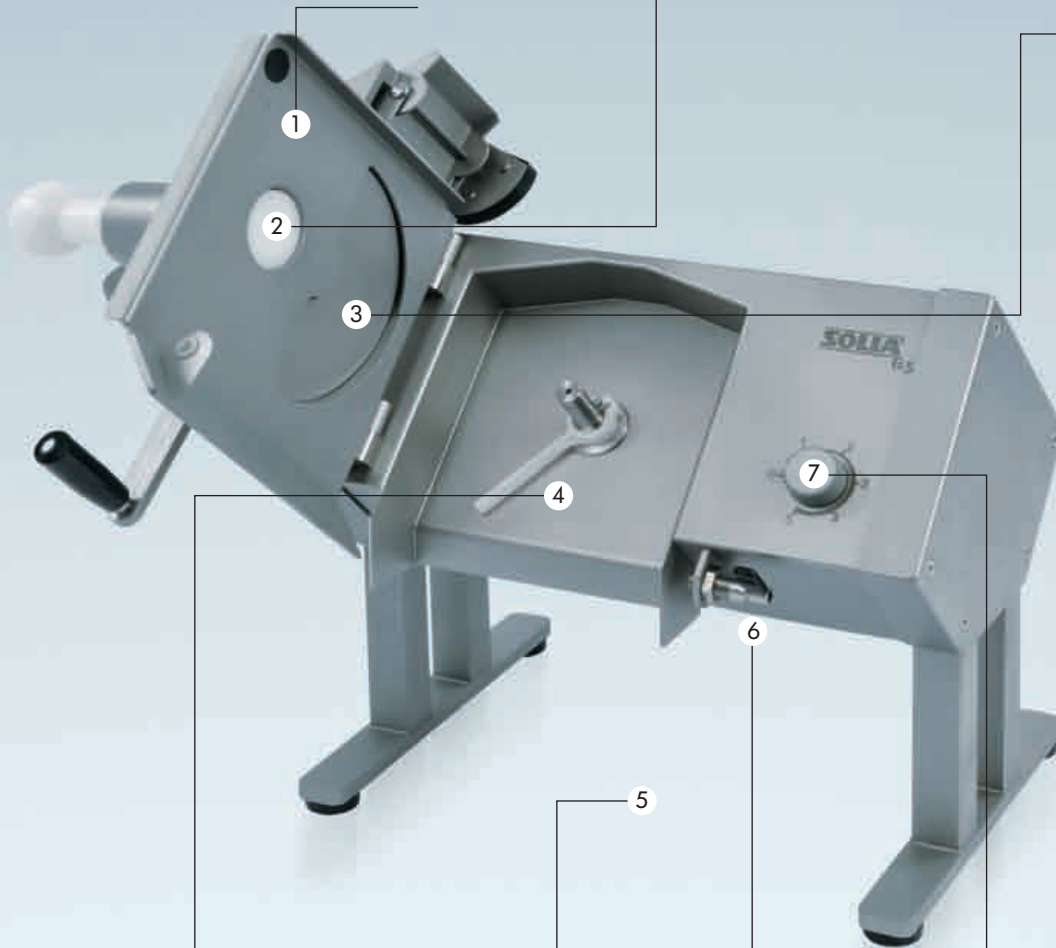

4 Basik carrier disc



5 Space for 1/1 GN-containers (150 mm high)



6 Safety catch at the side to latch the filler flap in place



7 Infinitely variable setting from 130 to 360 rpm

CUTTING DISCS AND ACCESSORIES



Curved blade disc,
stainless steel, double-
bladed, adjustable
0-5 mm 561 000 0352*

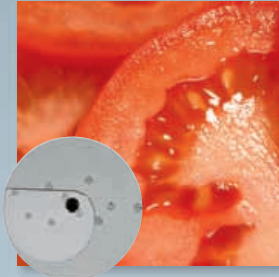

Curved blade disc,
stainless steel, single-
bladed, adjustable
0-10 mm 103 275 000

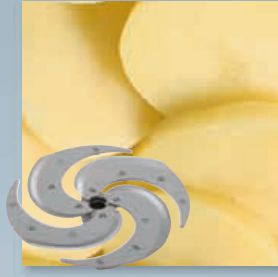

Crescent blade discs,
stainless steel
3 mm 561 000 0363
4 mm 561 000 0360*
6 mm 561 000 0361



Strip cutting discs,
stainless steel
2 x 2 mm Juliennes
561 000 0362*
4 x 4 mm Juliennes
561 000 0364
6 x 6 mm 561 000 0366
8 x 8 mm 561 000 0368

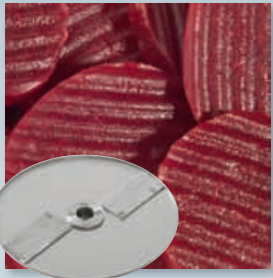

Crinkle cutting discs,
stainless steel
4 mm 561 000 0369
6 mm 568 000 0367



Basic carrier disc for
raw vegetable discs,
shredding discs,
grating discs,
potato grating disc,
potato pancake disc
Basic carrier disc,
stainless steel
568 000 0370*



Raw vegetable discs,
stainless steel,
hand sharpened
2 mm 561 000 0380
2.5 mm 561 000 0382
3 mm 561 000 0371*
4 mm 561 000 0374



Shredding discs,
stainless steel,
hand sharpened
6 mm 561 000 0372*
9 mm 561 000 0373



Grating discs,
stainless steel
2 mm 561 000 0381
3 mm 561 000 0375
4 mm 561 000 0378

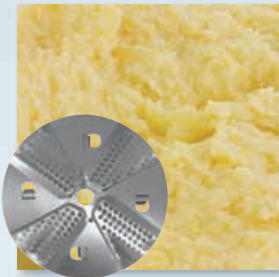

Potato grating disc,
stainless steel,
crown-toothed
561 000 0376



Potato pancake disc,
stainless steel,
partly crown-toothed,
combination of 376/380
561 000 0377



Dicer, complete
4 x 4 x 5 mm 105 040 000
5.5 x 5.5 x 5 mm 105 043 000
8 x 8 x 10 mm 105 046 000
11 x 11 x 10 mm 105 049 000*
16 x 16 x 10 mm 105 052 000
22 x 22 x 10 mm 105 055 000

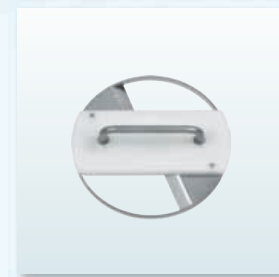

Protective hand grip
for dicer disc
105 040 190

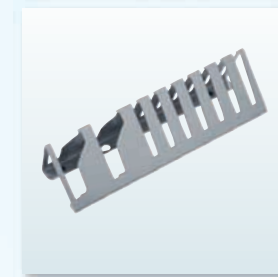

Multi disc rack, stainless
steel, for 2 discs and
7 exchange discs
561 000 0191*



Disc rack, stainless
steel, for 5 discs
561 000 0190

TECHNICAL DATA

Power supply	230 V, 50 Hz 2.5 m cable with CEE Euro plug
Output (kW)	0.37
Fuse protection (A)	16
Ingress protection	IP 54 (splash-proofed)
Infinitely variable speed control (rpm)	130-360 (variable)
Dimensions (L x W x H)	475 x 425 x 520 mm (max. 830 mm)
Weight (kg)	28

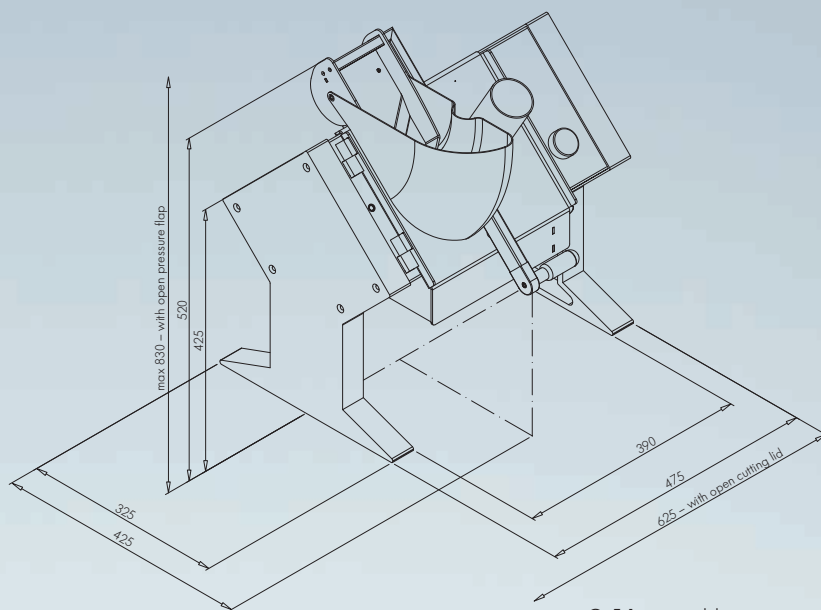

G 5.1 vegetable cutter
(Representation)

PROCESSING CAPACITY

Description	Use	Throughput**
Curved blade disc, single-bladed	Cutting of vegetables	50-200 kg/h
Curved blade disc, double-bladed	Cutting of soft vegetables	50-100 kg/h
Crescent blade discs, stainless steel	Cutting of boiled potatoes	80-150 kg/h
Shredding discs	Shredding of eg. celery, radish, potatoes, carrots, gouda cheese	120-200 kg/h
Grating discs	Grating e.g. bread, nuts, almonds, chocolates, cheese	50-120 kg/h
Potato grating disc	Grating e.g. potatoes, parmesan cheese	50 kg/h
Potato pancake disc	Grating e.g. potatoes	50 kg/h
Dicer	Dicing of vegetables, fruits	120-200 kg/h

**The throughputs are dependent on cutting thickness and product.

The figures shown here are for illustration only and may deviate from the actual design version. Technical alterations are reserved. For additional accessories please refer to our price list.

*Items marked with an asterisk are part of the basic equipment.